

# SAFETY RAILING - RSHWB - BOLT-ON INSTALLATION & MAINTENANCE GUIDE | 14I-419



## GENERAL:

Bolt-on safety railings are ideal for new roof hatch installation as they bolt on the curb counterflash. The following installation guide is the manufacturers recommended steps for installation. Please install according to local building codes and practices.

## TOOLS NEEDED:

(Provided by others)

- Power drill
- T30 Torx Bit (PN# TORX-T30-BIT)
- 1/4" Allen Wrench
- 1/4" Hex bit (for the set screws)

## INSTALLATION:

Note: It is preferable to install the safety rail with two people

1. Install the four corner brackets to the counterflash using a power drill with T30 Torx bit. (Fig. 1)
2. Use provided 1/4" x 3/4" self threading torx screws to install bracket into counterflash that has pre-drilled mounting holes. (Fig. 1 Close up view)

Note: Vertical posts have predrilled holes for mounting the gate hinges and latch. Confirm you have the correct vertical post in the right location. (Reference exact submittal with assembly)

3. Install vertical post into corner bracket, using 1/2"-13 x 2-1/2" bolts & 1/2"-13 flange nut. Select one of the three mounting positions in the corner bracket so that the top rail resides at 42" above the walking surface, to insure code compliance. Install all 4 vertical posts. (Fig. 2)

*Also, there may be multiple vertical posts with fittings to secure in place.*

4. Install the horizontal rails, making sure they are correctly located. (Fig. 3)
  - a.) Horizontal rails are secured in place using set screws. Be sure all set screws are backed out.
  - b.) Slide horizontal rails into brackets along top and middle locations.
  - c.) Use the 1/4" hex bit to tighten the 1/2"-13 x 3/4" set screws at the bottom of each bracket to tighten the horizontal rails.

*For larger safety railings there will be a swedged joint to combine the horizontal rails together. Then put the outside cap over it.*

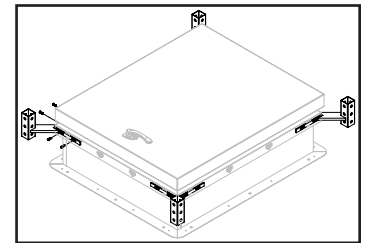
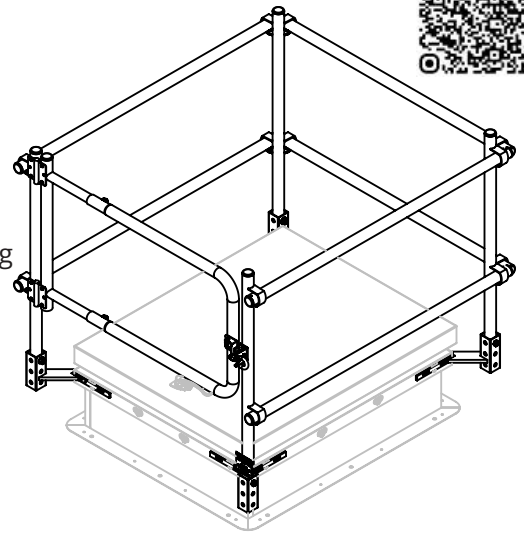

FIG. 1

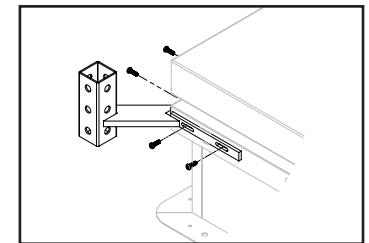

FIG. 1 - Close up view

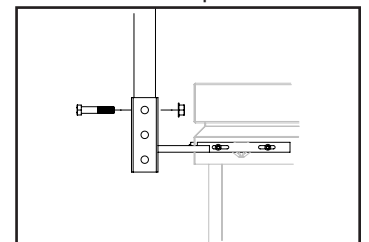

FIG. 2

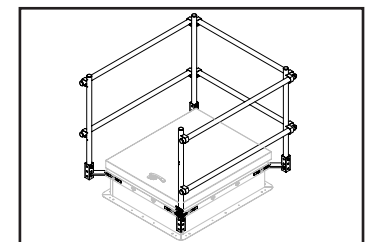

FIG. 3



JL INDUSTRIES



MAXAM  
METAL PRODUCTS



DUR-RED  
PRODUCTS

Distributed by  
www.Ameraproducts.com  
Phone: (800) 608-6568  
Fax: (407) 840-3342  
info@ameraproducts.com

Installation &  
Maintenance Guide  
14I-419

REV A 8-9-2024

# SAFETY RAILING - RSHWB - BOLT-ON - INSTALLATION & MAINTENANCE GUIDE

5. Install the gate. Our standard gate opens left handed, with the hinges on the left hand side.
  - a.) Disassemble telescoping gate into two pieces.
  - b.) Install both hinges of the hinged piece to the left hand corner post (Fig. 4)
  - c.) Install the latch catch assembly into the opposite corner post with the provided 1/4" -20 x 3/4" Torx screws using the T-30 Torx bit and drill. (Fig. 5)
  - d.) Screw the hook into the U bent gate piece using the 1/4"-20 x 3/4" Torx screws. (Fig. 6)
  - e.) Install telescoping side of the gate with installed hook onto the hinged piece to fit exit opening. Make sure the hook pin properly engages the latch catch and tighten set screws. (Fig. 7)
  - f.) Open the gate 90 degrees and release to verify the gate will self close and self latch. If needed, use 5/32" Allen wrench (included) to adjust the hinge spring tension.

## OPERATION:

Press the gravity latch catch up and pull open the gate. (Fig. 8) The gate automatically self-closes and self-latches with adjustable spring hinges.

NOTE: The standard gate opens left handed. If you need a right handed opening gate a special latch kit is required. (PN# RSH-KIT-LATCHPINL) .

## MAINTENANCE:

Manually operate once a year to check functionality of moving parts such as latches and hinges. Periodically clean latches and strikes of old grease and dirt using a clean dry cloth. Reapply lubrication as needed. Inspection shall include checking frame alignment, check that all nuts, bolts, and clamps are tight, weight distribution, and improper installation causing damage or failure.

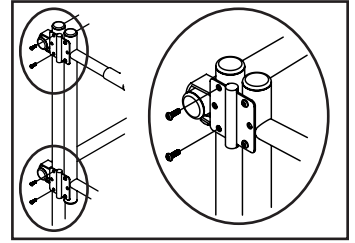

FIG. 4

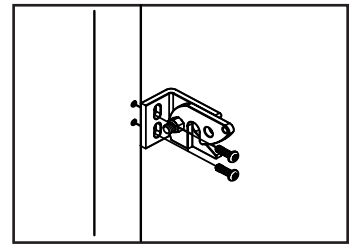

FIG. 5

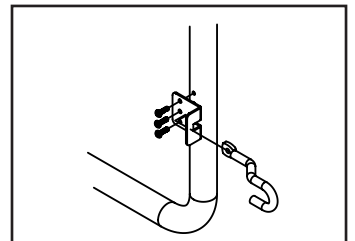

FIG. 6

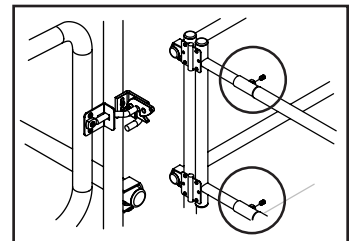

FIG. 7

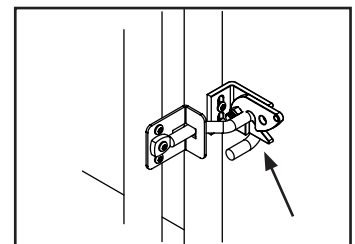

FIG. 8

