

ROOF ACCESSORIES - ROOF HATCH RETROMOUNT SERIES - RHRM

The RetroMount series roof hatch is a low profile replacement option for a damaged roof hatch without re-roofing. Simply remove the existing hatch cover and reuse the existing curb.

Specifications:

Material:

Curb: 14 gauge galvanized steel

Cover: 14 gauge with 22 gauge liner galvanized steel. Formed and welded cover with a liner. Supports a live load of 40psf.

Finish: White textured powder coat paint on steel

Gasket: Continuous, weatherproof EPDM sponge rubber adhesivebacked seal

Insulation: 1" polyisocyanurate in curb and cover with thermal resistance R-6

Hold Open Arm: Clear zinc-plated automatic locking hold open arm with red vinyl grip for one handed door operation

Latch: Clear zinc-plated steel slam latch with inside and outside handles and padlock hasps. Holds covers closed against a 20psf wind uplift.

Hinge: Heavy duty zinc plated steel pintle hinge system

Springs: Powder coated, oil tempered, steel torsion spring provides counterbalanced door lift assistance

Hardware: Zinc-plated steel anchor tabs included with 1/4-20x3/4" Philips head, self-tapping sheet metal screws for securing to inside of existing curb

Size (W x L): 36" x 30" (where L is hinged side)

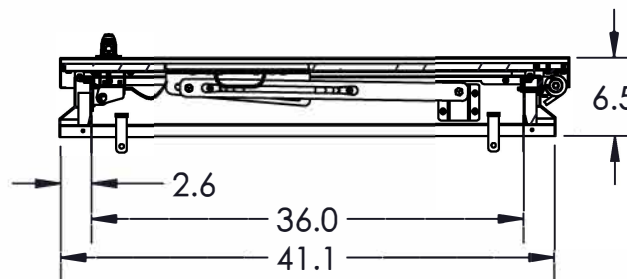
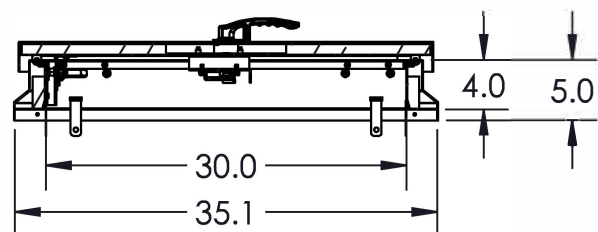
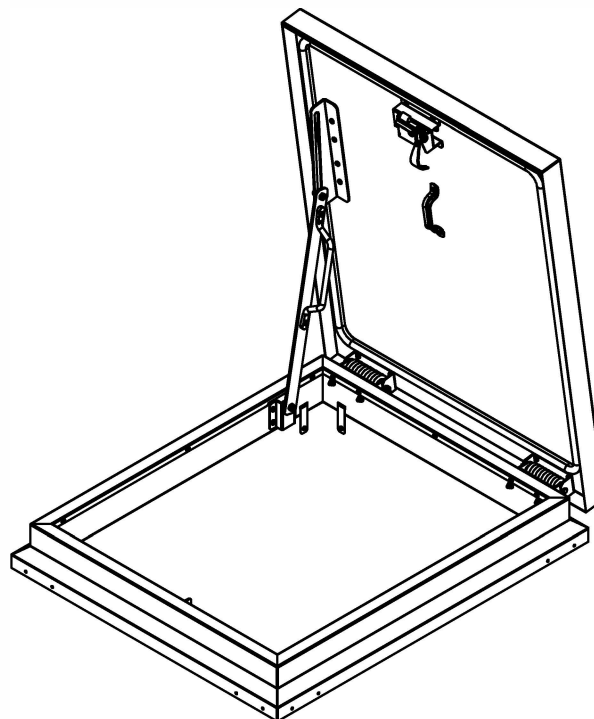
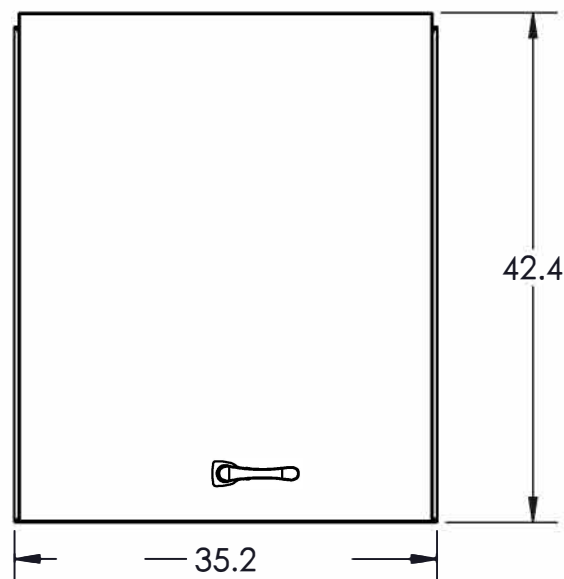

MODEL #: RHRMG-1WT



Distributed by
www.Ameraproducts.com
 Phone: (800) 608-6568
 Fax: (409) 840-5545
info@ameraproducts.com

Distributor:		Project:	
Contractor:		Approved By:	
Date:		Architect:	
Scale: 1:16	Pages: 1 OF 1	Drawing #:	RHRMG-1WT-SUBMITTAL