

SUBMITTAL: ACADEMY ALUMINUM FX2™ FIRE-RATED EXTINGUISHER CABINETS

The Academy Series Features Aluminum Trim and Door, with 10 Door Styles & Optional Anodized Colors.

Door & Trim Construction: Clear anodized aluminum. Flush cabinet doors with a 5/8" door stop are attached by a continuous hinge and equipped with zinc-plated handle and roller catch. All models have 1-3/4" wide trim on frame and 1-1/4" trim on doors with glazing. Rolled edge models are constructed of mechanically-joined extrusions, except for models 1827 and 1027 which are die formed. *Die formed corners provide an attractive, rounded edge - unique to the JL line of cabinets!*

Trim Style & Depth: Recessed 3/8" flat trim, Semi Recessed - 1-1/4", 1-1/2" Square Edge or 2-1/2", 3", 4", 4-1/2" Rolled Edge (4" has recessed FLUSH pull).

Tub: The tub is constructed of cold rolled steel with white powder-coat finish standard. Tub forms a flange to cover cut edges of wallboard material. Fire-resistant material is attached to the exterior of the tub. **Please note that dimensions for wall opening have changed. See Chart on pg 2.**

Fire-Rating: Fire-FX2™ cabinets are fabricated in accordance with the UL label for one and two hour combustible and non-combustible wall system building codes. The fire testing has met the requirement of ANSI/UL 1479 (ASTM -E814) and ULC/CAN S115 for membrane and penetration firestops. Installation instructions must be strictly adhered to in order to obtain the fire rating.



**8125D10FX2
Flat Trim
Semi-Recessed**



**1827G10FX2
3" Rolled Edge Trim
Semi-Recessed
With Saf-T-Lok™
Unique Die Formed
Rolled Corners!**



**Formed Rolled Edge
1027 and 1827**

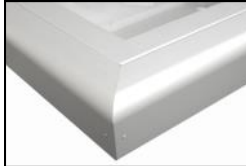

**Extruded Rolled Edge
2-1/2", 4" and 4-1/2"**

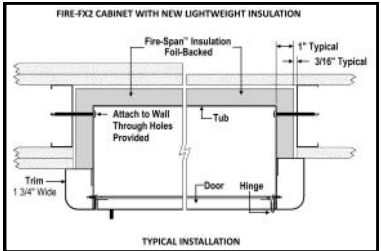

STEP 1: SELECT MODEL NUMBER AND QUANTITY ON CHART (refer to chart on pg 2)

A. Determine Trim Style according to wall depth. B. Determine Tub I.D. according to size most suited for extinguisher and wall opening.

STEP 2: SELECT DOOR STYLE WITH HANDLE

Check one box below Examples on Page 2

- | | |
|---|---|
| <input type="checkbox"/> F Full Glazing | <input type="checkbox"/> L22 Solid with SAF-T-LOK™ |
| <input type="checkbox"/> G Full Glazing with SAF-T-LOK™ | <input type="checkbox"/> L24 Sold with Cylinder Lock - No Handle |
| <input type="checkbox"/> D Horizontal Duo Panel | <input type="checkbox"/> V Vertical Duo |
| <input type="checkbox"/> E Horizontal Dual Panel with SAF-T-LOK™ | <input type="checkbox"/> W Vertical Duo with SAF-T-LOK™ |
| <input type="checkbox"/> S21 Solid Door | <input type="checkbox"/> B Solid with 2" x 4" View Window & SAF-T-LOK™ |



STEP 3: SELECT DOOR GLAZING

(Check one box below)

- | | | |
|--|---|---|
| <input type="checkbox"/> 10 Clear Acrylic | <input type="checkbox"/> 15 Bronze Acrylic | <input type="checkbox"/> 17 Clear Tempered Glass |
| <input type="checkbox"/> 13 Clear Wire Glass with Safety Film | <input type="checkbox"/> 16 Gray Acrylic | <input type="checkbox"/> 18 Laminated Safety Glass |

STEP 4: OPTIONAL FEATURES AT ADDED COST (SELECT ANY)

- | | | | |
|--|--|--|--|
| <input type="checkbox"/> Optional Tub Color: _ Black _ Red | <input type="checkbox"/> Black Vertical FE Letters LDCVBF | <input type="checkbox"/> Black Vertical Decal LDVBF | <input type="checkbox"/> (CA) Commander Alarm |
| <input type="checkbox"/> Futura "Fire" Pull _ Mill Alum _ Red _ White | <input type="checkbox"/> Red Vertical FE Letters LDCVRF | <input type="checkbox"/> Red Vertical Decal LDVRF | <input type="checkbox"/> (BA) Brigadier Alarm |
| <input type="checkbox"/> Flush Pull Handle | <input type="checkbox"/> White Vertical FE Letters LDCVWF | <input type="checkbox"/> White Vertical Decal LDVWF | <input type="checkbox"/> Etched Lettering in Glass or Engraved Lettering on Metal
(Separate submittal needed for special lettering) |
| <input type="checkbox"/> Polished Chrome Handle (PUCH) | <input type="checkbox"/> Black Horizontal FE Letters LDCHBF | <input type="checkbox"/> Black Horizontal Decal LDHBF | <input type="checkbox"/> Powder Coat Paint _ White Bronze _ Other Code |
| <input type="checkbox"/> Optional Anodized Color Finish: (with matching pull)
___ Dark Bronze | <input type="checkbox"/> Red Horizontal FE Letters LDCHRF | <input type="checkbox"/> Red Horizontal Decal LDHRF | Decals/Die Cuts & Wall Signs. More Alarm Information |
| | <input type="checkbox"/> White Horizontal FE Letters LDCHWF | <input type="checkbox"/> White Horizontal Decal LDHWF | |

 JL INDUSTRIES	 ACTIVAR INC. CONSTRUCTION PRODUCTS GROUP	Distributor:	Quantity:
	ACADEMY, FX2 AND SAF-T-LOK ARE TRADEMARKS OF ACPG PLEASE DOWNLOAD THE MOST CURRENT SUBMITTAL FROM WEBSITE BEFORE ORDERING	Contractor:	Approved By:
		Model #:	Architect:
		Project:	Date: © 2019 Activar Construction Products Group, Inc
HEADQUARTERS: 9702 NEWTON AV S, BLOOMINGTON, MN 55431 MANUFACTURING: BLOOMINGTON MN & COMMERCE, CA • WAREHOUSES: FT MYERS FL, ATLANTA GA, DALLAS TX, SEATTLE WA, LANCASTER PA, FARGO ND, OMAHA NE 3/20/2019			

SUBMITTAL: ACADEMY FX2 FIRE-RATED EXTINGUISHER CABINETS - PLEASE NOTE CHANGES IN WALL OPENING

TRIM & DOOR SERIES #			Tub I.D.			Frame O.D.		FX Wall Opening New Dimensions 1/23/15 - Please Note!			Fits Extinguishers View Submittal
QTY	Model	Trim Style	A	B	C	E	F	W	H	D	
	8125	Flat 3/8" Trim ●	9	18	5 1/2	12 3/8	21 3/8	11 5/16	20 5/16	6 7/16	Cosmic & Galaxy
	8126	1 1/2" Square ●	9	18	5 1/2	12 3/8	21 3/8	11 5/16	20 5/16	5 3/16	2 1/2-6 (6 lb must be mounted to tub wall),
	8127	2 1/2" Rolled ●	9	18	5 1/2	12 3/8	21 3/8	11 5/16	20 5/16	4 5/8	Mercury 2 1/2- 5
	1720	2-1/4" Square ●	10 1/2	24	5	13 7/8	27 3/8	12 13/16	26 5/16	4	Cosmic/Gal/Merc 2-5
	1825	Flat 3/8" Trim ●	10 1/2	24	5 1/2	13 7/8	27 3/8	12 13/16	26 5/16	6 7/16	Cosmic & Galaxy 2 1/2-6 (6 lb must be mounted to tub wall), Mercury 2 1/2-5
	1826	1 1/2" Square ●	10 1/2	24	5 1/2	13 7/8	27 3/8	12 13/16	26 5/16	5 3/16	
	1827	3" Formed Rolled ●	10 1/2	24	5 1/2	13 7/8	27 3/8	12 13/16	26 5/16	3 5/8	
	1822	4" Rolled/Flush Pull ●	10 1/2	24	5 1/2	13 7/8	27 3/8	12 13/16	26 5/16	3 1/2	
	1828	4 1/2" Rolled	10 1/2	24	5 1/2	13 7/8	27 3/8	12 13/16	26 5/16	2 13/16	
	1025	Flat 3/8" Trim ●	10 1/2	24	6	13 7/8	27 3/8	12 13/16	26 5/16	6 15/16	Cosmic & Galaxy 2 1/2-10 Mercury 2 1/2-5, Sentinel 5
	1026	1 1/2" Square ●	10 1/2	24	6	13 7/8	27 3/8	12 13/16	26 5/16	5 11/16	
	1027	3" Formed Rolled ●	10 1/2	24	6	13 7/8	27 3/8	12 13/16	26 5/16	4	
	1022	4" Rolled/Flush Pull ●	10 1/2	24	6	13 7/8	27 3/8	12 13/16	26 5/16	4	
	1028	4 1/2" Rolled	10 1/2	24	6	13 7/8	27 3/8	12 13/16	26 5/16	3 5/16	
	2025	Flat 3/8" Trim ●	12	27	7 3/4	15 3/8	30 3/8	14 5/16	29 5/16	8 9/16	Any **Cosmic, Galaxy, Mercury, Saturn or Grenadier P (20 lb must be mounted on back of tub), Sentinel 5 & 10
	2026	1 1/4" Square ●	12	27	7 3/4	15 3/8	30 3/8	14 5/16	29 5/16	7 9/16	
	2027	2 1/2" Rolled ●	12	27	7 3/4	15 3/8	30 3/8	14 5/16	29 5/16	7 1/16	
	2022	4" Rolled/Flush Pull ●	12	27	7 3/4	15 3/8	30 3/8	14 5/16	29 5/16	5 3/4	
	2028	4 1/2" Rolled	12	27	7 3/4	15 3/8	30 3/8	14 5/16	29 5/16	5 1/16	
	3025	Flat 3/8" Trim ●	16	32	7 3/4	19 3/8	35 3/8	18 5/16	34 5/16	8 9/16	Any **Cosmic, Galaxy, Mercury, Saturn or Grenadier P (20 lb must be mounted on back of tub), Sentinel 5-15, 272
	3026	1 1/4" Square ●	16	32	7 3/4	19 3/8	35 3/8	18 5/16	34 5/16	7 9/16	
	3027	2 1/2" Rolled ●	16	34	7 3/4	20 3/8	38 3/8	18 5/16	34 5/16	7 1/16	
	3022	4" Rolled/Flush Pull ●	16	32	7 3/4	19 3/8	35 3/8	18 5/16	34 5/16	5 3/4	
	3028	4 1/2" Rolled	16	32	7 3/4	19 3/8	35 3/8	18 5/16	34 5/16	5 1/16	
	4025	Flat 3/8" Trim ●	20	27	7 3/4	23 3/8	30 3/8	22 5/16	29 5/16	8 9/16	Two each of: any **Cosmic, Galaxy, Mercury, Saturn or Grenadier P (20 lb must be mounted on back of tub), Sentinel 5
	4026	1 1/4" Square ●	20	27	7 3/4	23 3/8	30 3/8	22 5/16	29 5/16	7 9/16	
	4027	2 1/2" Rolled ●	20	27	7 3/4	23 3/8	30 3/8	22 5/16	29 5/16	7 1/16	
	4022	4" Rolled/Flush Pull ●	20	27	7 3/4	23 3/8	30 3/8	22 5/16	29 5/16	5 3/4	
	4028	4 1/2" Rolled	20	27	7 3/4	23 3/8	30 3/8	22 5/16	29 5/16	5 1/16	

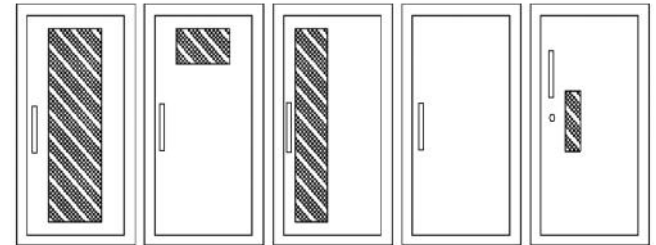
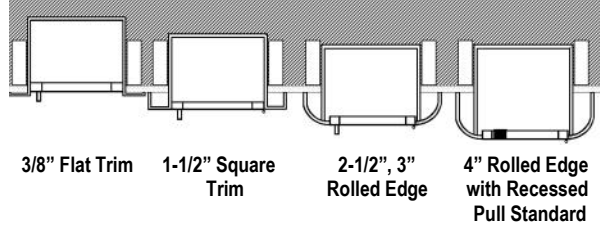
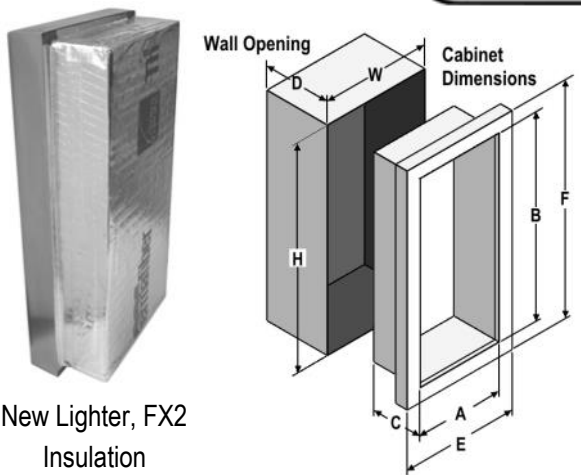

F - Full glass with pull handle
G - Full glass with pull handle above Saf-T-Lok (not shown)
D - Horizontal duo panel with pull handle
E - Horizontal duo panel with pull handle above Saf-T-Lok (not shown)
V - Vertical duo panel with pull handle
W - Vertical duo panel with pull handle above Saf-T-Lok (not shown)
S21 - Solid with pull handle
L22 - Solid with pull handle above Saf-T-Lok
L24 - Solid with cylinder key lock and no handle
B - Small view window with pull handle, and Saf-T-Lok

Model Numbers shown in **Large Bold** above are available in several door styles for Quick Shipment.

● Cabinets that Meet 4" Maximum ADA Projection Requirement

Cabinet Mounting Height: Standard Pull on G, E, W, L22 and B Door Styles with Saf-T-Lok are 3 5/8" Higher than Door Center, so Allow for that When Mounting Cabinet. Standard Pull with No Lock or FLUSH Recessed Pull are Centered on Door.